

**SALES EXAMPLE ONLY
NOT FOR CONSTRUCTION**

DISCHARGE

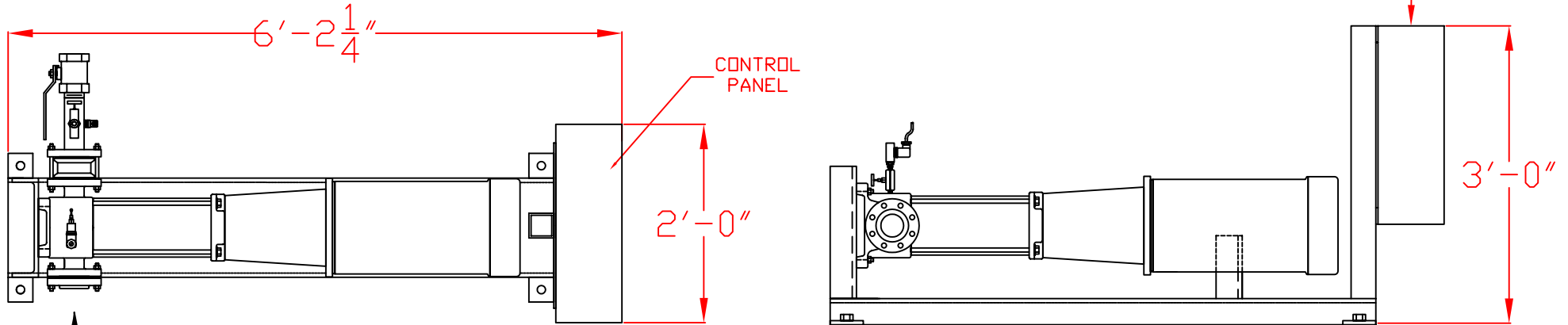

SUPPLY

**75 GPM @ 700' TDH (300psi)
25 HP 460/3/60
2" x 2" FNPT CONNECTIONS**

**HORIZONTAL CONFIGURATION
INLINE BOOSTER PACKAGE
CR 15-12**

INLINE BOOSTER PACKAGE CR 15-12 SKID PLAN VIEW	
DRAWN BY: MJH	CHECKED:
DATE: 02-14-2008	APPROVED: JDC
SCALE: NTS	
DRAWING NUMBER:	
XXXX08-M1	
REV: 0	SHEET: 1 OF 1

NO.	DATE	REVISION	BY

THIS DRAWING AND THE INFORMATION SHOWN HEREON IS THE EXCLUSIVE PROPERTY OF TORRENT ENGINEERING AND EQUIPMENT, LLC, AND SHALL NOT BE REPRODUCED OR DISCLOSED TO ANY THIRD PARTY WITHOUT PRIOR WRITTEN CONSENT FROM THE COMPANY.



TORRENT Engineering and Equipment

P.O. BOX 270 MILFORD, IN 46542 USA
 Phone: (574)-658-3200 Fax: (574)-658-3229 www.torrentee.com